

Medidas y datos: INOX-STAR-Cáncamo M12 - L=50

Nº de artículo: 7997822

weight:	0,22 kg	0,49 lbs
Nominal WLL:	500 kg	1100 lbs
B:	14 mm	9/16"
T:	43 mm	1-11/16"
C:	12 mm	15/32"
D:	30 mm	1-3/16"
E:	30 mm	1-3/16"
G:	32 mm	1-1/4"
I:	20 mm	3/4"
K:	56 mm	2-3/16"
L:	50 mm	1-31/32"
M:	M12	M12
N:	8 mm	5/16"

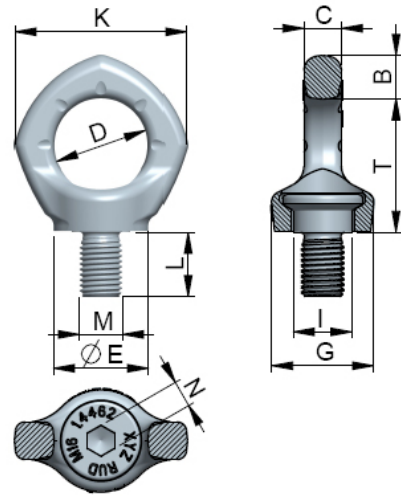

Max. peso transportable en kg para diferentes tipos de carga

1 Ramal:

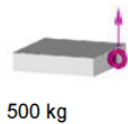
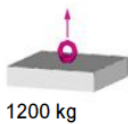

2 Ramales:

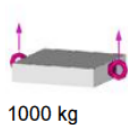
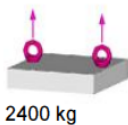

vertical:

3/4 Ramales:*

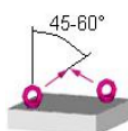
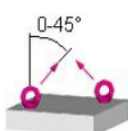
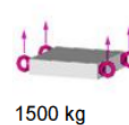
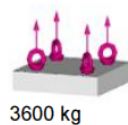

simétrico:

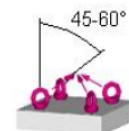
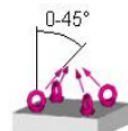

Asimétrico:

