

## Medidas y datos: Cáncamo giratorio en acero inoxidable INOX-STAR M20

Nº de artículo: Z993837

<b>weight:</b>	0,53 kg	1,17 lbs
<b>Nominal WLL:</b>	2000 kg	4400 lbs
<b>B:</b>	19 mm	3/4"
<b>T:</b>	57 mm	2-1/4"
<b>C:</b>	16 mm	5/8"
<b>D:</b>	40 mm	1-9/16"
<b>E:</b>	42 mm	1-21/32"
<b>G:</b>	47 mm	1-7/8"
<b>I:</b>	29 mm	1-5/32"
<b>K:</b>	74 mm	2-29/32"
<b>L:</b>	30 mm	1-3/16"
<b>M:</b>	M20	M20
<b>N:</b>	12 mm	15/32"

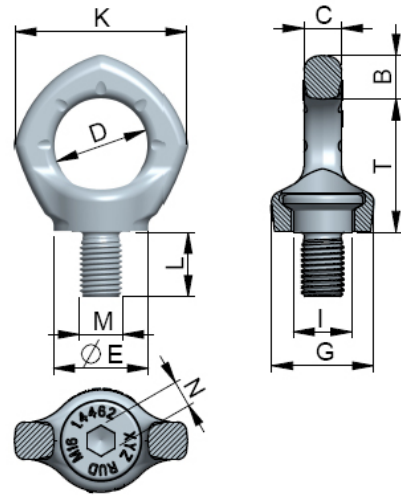

### Max. peso transportable en kg para diferentes tipos de carga

#### 1 Ramal:

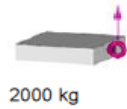
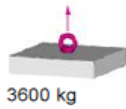

#### 2 Ramales:

vertical:

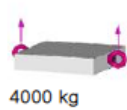
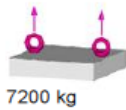

#### 3/4 Ramales:\*

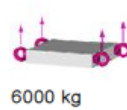
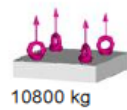

simétrico:

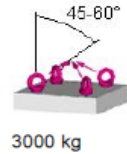
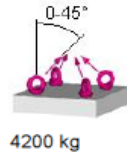
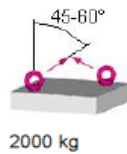
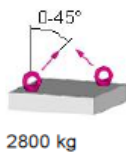

Asimétrico:

